

1. Accessories

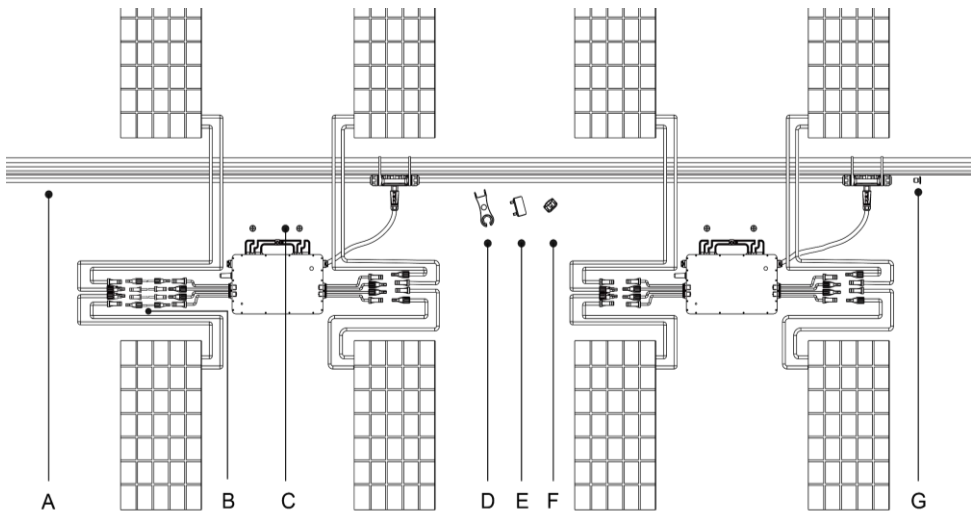

Item	Description
A	AC Bus Cable, 12/10 AWG Cable
B	DC Extension Cable, 1m
C	M8*25 screws
D	AC Connector Unlock Tool
E	Bus Connector Unlock Tool
F	AC Sub Cap
G	AC Bus End Cap, IP67

*Note: All accessories above are not included in the package, and need to be purchased separately. Please contact our sales representative for the price. (M8 screws need to be prepared by installer-self.)

2. Installation Steps

Please make sure the microinverter is installed under the required environment. (Please refer to product user manual for more details.)

2.1 Pre-installation

- A) Plan the cable length to make the bus cable aligned with each PV module.
- B) Install the AC bus end cap:
 - Uses the bus connector unlock tool to unlock the port upper cover;

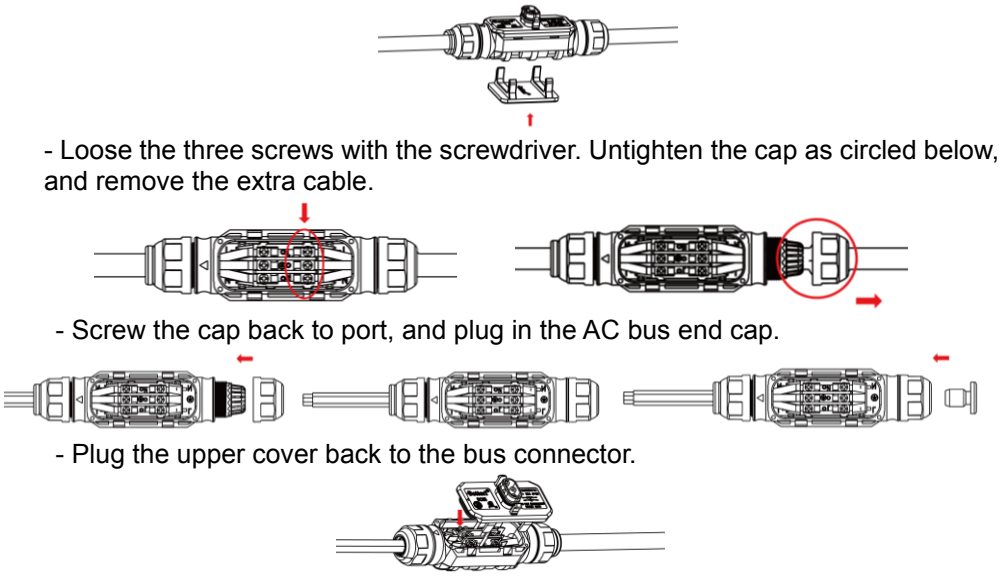

2.2 Installation Steps

Step 1. Fix Microinverter on the Rail

- A) Mark the approximate center of each panel on the frame.
- B) Fix the screw on the rail.
- C) Hang the microinverter on the screw (shown as picture below), and tighten the screw. The silver cover side of the microinverter should be facing the panel.

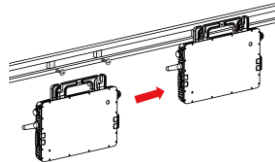

*Note: Please install the microinverter at least 50cm above the ground/roof for better communication with Hoy miles DTU.

Step 2. Complete the AC Connection

- A) Attach the AC bus cable to the mounting rail, and fix the cable with tie wraps.



B) Push the AC connector of microinverter to the trunk cable connector until you hear “click”.



C) If there is any vacant bus port, please plug the AC sub cap on the vacant plug to ensure waterproof and dustproof.

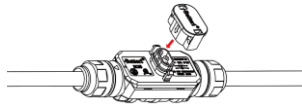

**Note: Under the circumstances that need to remove the inverter AC cable from bus port, please use the AC connector unlock tool and insert the tool into the side of AC port.*

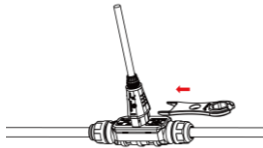

Step 3. Install AC End Cable

A) Prepare the AC end cable with the proper length, and insert one side of the cable into the cap. Match the L, N and Ground line into the slot accordingly. Tighten the screws, and then tighten the cap back to the port. Plug the upper cover back to the bus connector.

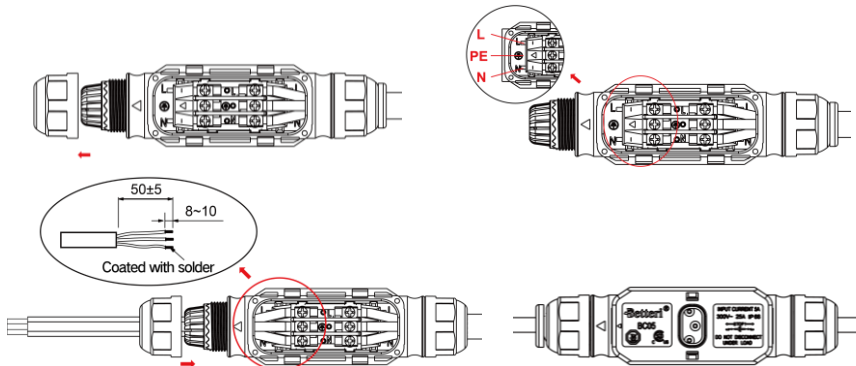

B) Connect the other side of the AC end cable to the distribution box, and wire it to the local grid network.

Step 4. Create an Installation Map

- A) Peel the removable serial number label from each microinverter (The position of the label is shown as below.)
- B) Affix the serial number label to the respective location on the installation map.

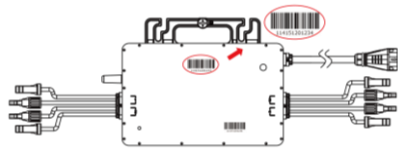

In. D. # or Inverter Model	Panel Config: A: number B: size Sheet ... of ...		Customer Information:				DTU Serial Number:				hoymiles			
	1	2	3	4	5	6	7	8	9	10	11	12	13	14
A														
B														
C														
D														

Step 5. Connect PV Modules

- A) Mount the PV modules above the microinverter.
- B) Connect the PV modules' DC cables to the DC input side of the microinverter.

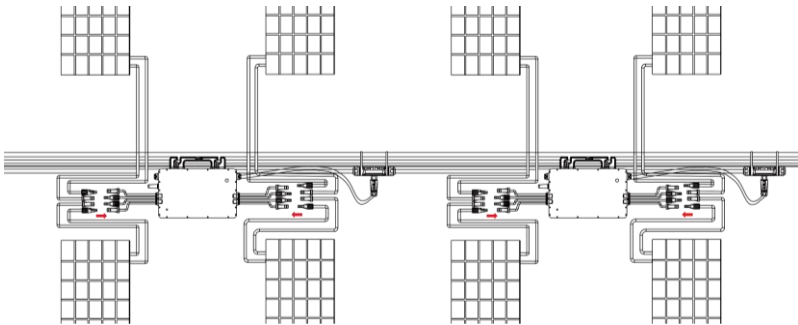

Step 6. Energize the System

- A) Turn on the AC breaker of the branch circuit.
- B) Turn on the main AC breaker of the house. Your system will start to generate power after about two-minute wait time.

Step 7. Set Up the Monitoring System

Refer to the DTU User Manual or DTU Quick Install Guide, and Quick Installation Guide for HMP Online Registration to install the DTU and set up your monitoring system.

Product information is subject to change without notice. (Please download reference manuals at www.hoymiles.com.)